

/

# SNAIGÉ



**CD29DM**  
**CD35DM**

---

---

---

**Vertical refrigerator showcase**

Instructions for Use

1

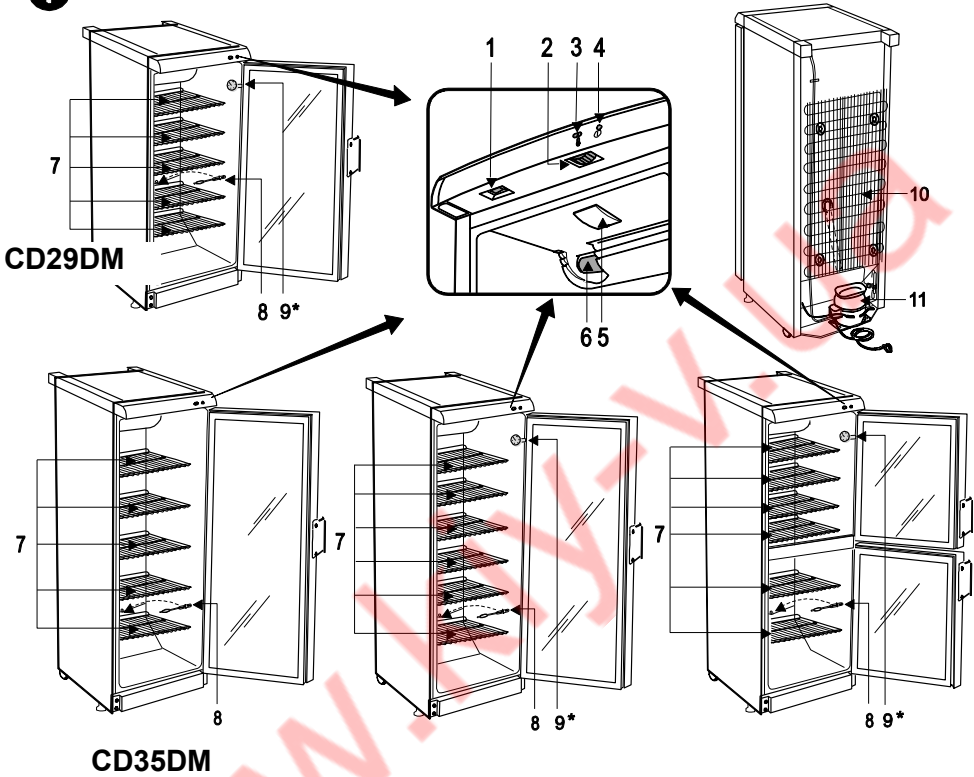

2

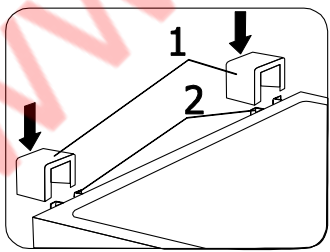

3

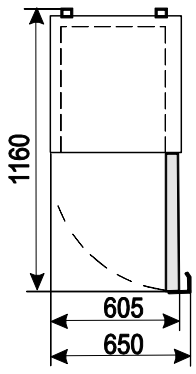

CAREFULLY READ THE INSTRUCTION MANUAL. If instructions are not followed, there is a risk of injury, damage of the appliance and loss of the right to free warranty service. The Manufacturer shall not be held liable for damage arising from the failure to observe the instructions contained in this manual.

We recommend to keep the Instruction manual the whole time you have the appliance. When you sell the appliance pass the Instruction manual to the new owner of the appliance.

### **General information:**

The appliance is a vertical beverage cooler with glass doors and is designed for chilling of drinks, for storage of foodstuffs and for a short-term storage of them. **This appliance is intended for commercial use!**

THE MANUFACTURER GUARANTEES RELIABLE OPERATION OF THE REFRIGERATOR WHEN THE AMBIENT TEMPERATURE IS +16 TO +32 DEGREES CELSIUS AND THE RELATIVE AIR HUMIDITY NOT GREATER THAN 65 PER CENT.

This refrigerator is free-standing and not intended for use as a built-in appliance.

## **SAFETY INSTRUCTIONS**

### **General safety requirements:**

- WARNING: Do not cover the ventilation holes at the top and on the sides of the appliance.
- WARNING: Do not use any mechanical means or electrical devices to hasten the thawing process when cleaning the freezer compartment.
- WARNING: Do not use electrical appliances inside the food storage compartments of the appliance, unless they are of the type recommended by the manufacturer.
- WARNING: When positioning the appliance, ensure the supply cord is not trapped or damaged.
- WARNING: Do not locate multiple portable socket-outlets or portable power supplies at the rear of the appliance.

WARNING: Disposal of the appliance should be according to national rules.



WARNING: risk of fire / flammable materials. Do not damage the appliance refrigeration system. It contains the refrigerant gas R600a. If the refrigeration system is damaged:

- Do not use any open flame.
- Avoid sparks — do not turn on any electrical appliances or lighting fixtures.
- Immediately ventilate the room.

- Air the room in which the appliance is placed for a few minutes (the size of the room for a product containing isobutane / R600a must be at least 4 m<sup>3</sup>) to avoid damage to the cooling system.



C-Pentane is used as blowing agent in the insulation foam and it is a flammable gas.

- This appliance is not designed for the storage of explosive substances such as aerosol cans with a flammable propellant.
- It is prohibited to store petrol and other flammable liquids near the appliance.
- The appliance should be used only for storing foodstuffs
- Once the appliance is unpacked, make sure that it is complete, that the body and the electrical cord aren't damaged. It is forbidden to use a technically damaged appliance.
- The appliance should only be connected to an earthed socket installed in accordance with the regulations. Make sure that the supply voltage corresponds with the voltage marked on the rating label. This product complies with all binding CE labelling directives. The earthed electrical socket by which the appliance is connected to the mains should be in an accessible place. It is a legal requirement that the appliance is properly earthed. The manufacturer will not be held liable for any damage or injury which may result from the failure to fulfil this requirement.
- To avoid the exposure to danger, always have faulty cable be replaced only by the manufacturer, by our customer service or by qualified person and with a cable of the same type.
- Do not use adapters, multiple sockets and two-wire extension leads. If it is necessary to use the extension lead, it must be equipped with a protection ring and a single socket and must have a VDE/GS safety certificate.
- The frequency and power of the electricity supply must conform to the general data parameters of the appliance as it is shown in the product label.
- When positioning the appliance, be careful that the electrical cord isn't squeezed in order to avoid its damage. Do not store heavy objects such as cooling devices, furniture or other devices next the appliance in such a way that they could squeeze and damage the electrical cord. This can cause a short circuit and a fire.
- Make sure that the plug of the electrical cord is not squeezed by the back wall of the appliance or otherwise damaged. A damaged plug can be the cause of a fire!

- CAUTION! If the installed interior lighting diode (LED) lamp for the cooling device is not functioning, contact the maintenance and repair representative for replacements. LAMPS CAN BE REPLACED ONLY BY THE MAINTENANCE AND REPAIR REPRESENTATIVE.

 If the appliance is out of order and it is not possible to repair it by means of given recommendations, unplug it, open the doors and call the service expert. Only a service representative can remedy all technical or construction faults

- If the appliance is unplugged (for cleaning, moving to another place, etc.), it may be repeatedly switched on after 15 min.
- Pull the plug out from the mains socket before each maintenance activity. Do not pull on the cord, but hold the body of the plug instead.
- The appliance should be used only for storing foodstuffs.
- This appliance is not designed for the storage of explosive substances such as aerosol cans with a flammable propellant.
- It is prohibited to store petrol and other flammable liquids near the appliance.
- The appliance can't be disposed of by burning.
- Do not place any switched on electrical devices on top of the appliance because this may cause ignition of plastic parts.
- Do not place any dishes with liquids on top of the appliance and do not keep flowers in vases or other liquid-filled vessels on the appliance. Do not lean on or hang on the appliance doors and do not allow children to do this.

 **The appliance should be transported only in the vertical position.** THE MANUFACTURER WILL NOT BE RESPONSIBLE FOR ANY DAMAGE OF THE APPLIANCE THAT RESULTS FROM NON-COMPLIANCE WITH THE INSTRUCTIONS FOR TRANSPORTATION.

## INSTALLATION AND OPERATING CONDITIONS

### Positioning:

- This appliance can be installed in a dry, well ventilated indoor where the ambient temperature corresponds to the climate class indicated on the rating plate of the appliance

 **WARNING!** The appliance should not be operated in an unheated room or porch. Place the appliance away from heat sources such as kitchen stove/oven, radiators, or direct sunlight.

The rear wall of the appliance, in particular, the condenser and other elements of the cooling system must not contact other elements, which may damage them, (e.g. central heating pipes and the water supply pipes).

- Do not cover the ventilation holes at the top of the appliances – it must be a good air circulation around the appliance. There should be a gap of at least 10 cm between the top of the appliance body and any furniture that may be above it. If this requirement is not followed, the appliance consumes more electrical energy and its compressor may overheat.
- If the appliance is placed in a corner, a gap of at least 1 cm must be left between the appliance body and the wall (see fig. 3, page 1).
- The appliance must stand on a level surface and must not touch the wall. If necessary, regulate the height of the appliance by adjusting the levelling feet: by turning them clockwise – the front of the appliance rises, by turning them counter clockwise – it comes down. If the appliance is tilted slightly backward – the doors will close by themselves.

### Preparing the appliance for operation:

It is recommended to prepare the appliance for operation with a helper.

- Remove package. Lift the appliance away from foamed polystyrene base.
- The device must only be transported in its vertical position; do not tilt any more than 30°.
- Therefore take out adhesive tapes from sides and simply lift the appliance up and take out the board. Strip adhesive tapes off and open the door. Remove the spacer above the door.
- When positioning the appliance in chosen location, it will move more easily into position if you lift the front a little and incline it backward allowing it to roll on its casters. **When placing, moving, lifting the appliance, do not hold the door handles, do not pull the condenser at the rear part of the refrigerator and do not touch the compressor unit.**
- Take two supports from the bag and insert them into the guides at the top back part of the appliance (see fig. 2, page 1).



The appliance should **not be connected to the mains** until all packing and transport materials aren't removed. Suitably dispose the packaging material.

- Once the unit has been positioned, wait for about 30 minutes before it is connected to the mains.



**If the device has been tilted more than 30° during transport, allow it to stand in an upright position for at least 4 hours before it is connected to the mains.** If this is not done, the appliance compressor may fail.

## THE APPLIANCE BASIC PARTS (see page 1. fig. 1)

<b>1</b> On/ off switch for interior light <b>I</b> -(ON) <b>O</b> -(OFF)	<b>7</b> Adjustable height shelves
<b>2</b> Thermostat knob	<b>8</b> Thaw water channel cleaner
<b>3</b> Thermostat indicator	<b>9</b> Thermometer (if available)
<b>4</b> Electricity supply indicator When the appliance is connected to the electricity supply, the green indicator light is illuminated.	<b>10</b> Condenser
<b>5</b> Interior light block (LED)	<b>11</b> Compressor
<b>6</b> Fan. <b>WARNING!</b> The fan switches on and continuously operates!	

**ATTENTION!** The manufacturer reserves the right to change the technical parameters and configuration of the products in the operating instructions in the future.

### TEMPERATURE REGULATION

The temperature in the device compartment is controlled using the thermostat knob **2** (see fig. 1) by turning it to one side or the other. The temperature indication in digits is shown beside the thermostat knob. When the door is closed, the temperature setting can be seen on the thermostat indicator display **3** (see fig. 1, page 1). The numbers "0, 1, 2, 3, 4, 5" do not mean a specific temperatures.

The temperature is regulated on the scale of five digits.

**0** = Compressor is switched off **WARNING! Electric current is not switched off.**

**1** = highest temperature (lowest cooling)

**5** = lowest temperature (highest cooling)

 THE TEMPERATURE IN THE DEVICE COMPARTMENT MAY VARY DEPENDING ON AMBIENT TEMPERATURE, THE AMOUNT OF FOODSTUFFS, THE TEMPERATURE OF THE FOODSTUFFS, AND HOW OFTEN THE APPLIANCE DOORS ARE OPENED AND CLOSED.

 If the room is cool, the appliance cools less. The temperature in the appliance may therefore rise. Use the thermostat wheel to set a lower temperature.

### DEFROSTING, CLEANING AND CARE

THE REFRIGERATOR COMPARTMENT DEFROSTS AUTOMATICALLY. Drops of ice that form on the back wall of the refrigerator compartment thaw during the time the compressor is not working and the thaw water runs down the thaw water runoff channel to the tray on top of the compressor, where it evaporates.

REGULARLY CLEAN THE APPLIANCE.



**Remember that before cleaning the back part of the appliance body you must disconnect the appliance from the electrical energy supply socket by pulling the plug out of the electricity outlet.**

- Protect the appliance inner surfaces and plastic parts from fats, acids and sauces. In case of accidental spills – immediately clean with warm soapy water or dishwashing detergent. Wipe dry inner and outer surfaces.
- Regularly clean the hermetic gaskets of the doors. Wipe dry.
- REGULARLY CLEAN THE THAW WATER CHANNEL SPACE WITH A SPECIAL CLEANER **8** FOR THAT PURPOSE (see fig. 1, page 1).
- At least once a year clean dust away from the back part of the appliance body and the compressor. A soft brush, electrostatic cloth or vacuum cleaner may be used for cleaning.
- DO NOT use detergents containing abrasive particles, acid, alcohol or benzene for cleaning the appliance inner and outer surfaces. DO NOT use for cleaning cloths or sponges that have coarse surfaces intended for scrubbing. Outer of the doors – glass – clean with agents intended for glass cleaning.
- IF THE APPLIANCE IS TO BE LEFT SWITCHED OFF FOR AN EXTENDED PERIOD, LEAVE ITS DOORS OPEN.

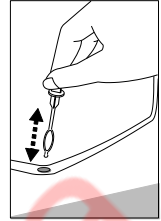

## **OPERATION PROBLEMS AND THEIR SOLUTIONS. What if ...**

- **The appliance is plugged in to the mains but it does not work and the electricity supply voltage indicator is not illuminated.** Check that your house electricity supply installations are in order. Check that the plug is correctly inserted into the electricity supply socket.
- **The noise has become louder.** Check that the appliance is standing stable, on a level place. To make it level, regulate the front feet. Check if the appliance is not touching any furniture, and that no part of the refrigeration system at the back part of the appliance body is touching the wall. Pull the appliance away from any furniture or walls. Check that the cause of increased noise isn't due to bottles, cans in the appliance that might be touching each other.
- **Water has appeared at the bottom of the refrigerator compartment.** Check whether a thaw water channel space isn't blocked. Clean the thaw water channel space with a cleaner intended for that purpose.
- **Water has appeared under the appliance.** The thaw water collection tray has slipped off the compressor. Place the tray on top of the compressor.
- **When the appliance door is opened, the rubber sealing gasket pulls out.** The gasket is smeared with sticky foodstuffs (fat, syrup). Clean the sealing gasket and the groove for it with warm water containing soap or dishwashing detergent and wipe dry. Put the rubber sealing gasket back into the place.
- **High temperature in appliance, the compressor operation pauses are short.** Ascertain whether the appliance door/doors are shutting tightly, whether the door wasn't kept open longer than necessary when taking out or putting in foodstuffs or whether a large amount of warm food was placed in the appliance.
- **The top of the appliance has condensation on it.** The ambient relative air humidity is above 65 %. Ventilate the room where the appliance stands and if possible remove the cause of the humidity.



**Remarks on the appliance operating noise.** As the appliance operates and goes through the freezing cycle, various noises will be emitted. This is normal and is not a sign of any malfunction.

- As the refrigerant circulates around the refrigeration system, it causes sounds like murmuring, bubbling, or rustling. Louder sounds like popping or clicking may be heard for a short time as the refrigerator compressor switches on.

## ENVIRONMENTAL PROTECTION INFORMATION



If the appliance is no longer in use, cut the connecting cable off the used equipment before its scrapping. Also, remove the appliance lock or render it useless so that the appliance presents no danger to children while being stored for disposal. This appliance is marked with a symbol of the crossed out waste container in conformance with the European Directive 2002/96/EC. Such marking informs that the equipment may not be kept together with other waste coming from the household after the period of its use. The user is obliged to dispose of the appliance at the waste collection point. The local waste collection points, shops and communal units form an appropriate system enabling the disposal of the equipment.

Handling the used electrical and electronic equipment properly contributes to the avoidance of consequences harmful to the human health and natural environment, resulting from the presence of hazardous substances and improper storage and processing of such equipment

## WARRANTY SERVICE

IF YOUR APPLIANCE IS NOT WORKING PROPERLY, ASCERTAIN WHETHER YOU CAN REMEDY THE CAUSE OF THE FAULTY FUNCTIONING OF THE APPLIANCE YOURSELF. If you cannot solve the problem yourself, contact the nearest refrigerator service representative by telephone or in writing. When making contact necessarily indicate the refrigerator model and number. You will find this data on the product label, which is glued to the wall of the refrigerator compartment.

### ATTENTION!

The technical data of the refrigerator can be found on the product label affixed to the inner wall of the refrigerator. For more information on the device, scan the QR code on the enclosed energy label and / or visit the official product database website: <https://eprel.ec.europa.eu>.