

**KRUPPS**<sup>®</sup>  
DISHWASHER MACHINES 

# CUBE Line

Lavabicchieri  
Lavastoviglie  
Lavastoviglie a traino  
Lavaoggetti

*Lave-verres  
Lave-vaisselle  
Lave-vaisselle à  
avancement automatique  
Lave-ustensiles*

*Gläserspüler  
Geschirrspüler  
Korbdurchlaufmaschinen  
Universalspülmaschinen*



*So shine, so*  **KRUPPS**<sup>®</sup>  
DISHWASHER MACHINES 



## Oltre 45 anni di esperienza per una tecnologia in evoluzione.



*Une expérience de plus de 45 ans pour une technologie en constante évolution.*

*Mehr als 45 Jahre Erfahrung für eine sich ständig weiterentwickelnde Technologie.*

Mettiamo a vostra disposizione sistemi di lavaggio professionali, progettati e realizzati allo scopo di ottenere eccellenti risultati di pulizia, igiene e brillantezza. Prodotti di qualità all'insegna di una politica di risparmio energetico e minor consumo di acqua e detersivi.

*Nous mettons à votre disposition des systèmes de lavage professionnels, projetés et réalisés pour obtenir d'excellents résultats de nettoyage, hygiène et brillance. Produits de haute qualité conçus en poursuivant une politique d'épargne énergétique avec une moindre consommation d'eau et de détergents.*

*Wir bieten Ihnen leistungsfähige gewerbliche Spülsysteme, die geplant und angefertigt werden, um ausgezeichnete Reinigungs-, Hygiene- und Glanzergebnisse zu erzielen. Produkte hoher Qualität, die eine energiesparende Politik des geringsten Wasser- und Spülmittelverbrauchs betreiben.*



# 100% Made in Italy

AFFIDABILITA'  
PRESTAZIONI  
ASSISTENZA GARANTITA  
MATERIALI RoHS

*FIABILITÉ*  
*HAUTES PERFORMANCES*  
*ASSISTANCE GARANTIE*  
*MATÉRIELS RoHS*

ZUVERLÄSSIGKEIT  
HOHE LEISTUNGEN  
GARANTIERTE BETREUUNG  
RoHS-KONFORME MATERIALIEN



# Impronta Naturale

*Empreinte Naturelle*

*Natürliche Spur*

Noi di Krupps siamo “sostenibili” di carattere.

Da più di 45 anni Krupps progetta e costruisce prodotti innovativi nel pieno rispetto della Natura.

Nasce così EcologyCare, il nuovo logo che garantisce un basso impatto ambientale, un maggior risparmio di acqua ed energia elettrica oltre che un lavaggio e un’igiene a prova di professionista.

*Krupps a un caractère “soutenable”.*

*Depuis 45 ans Krupps projette et construit produits innovateurs dans un respect le plus total de la Nature.*

*De cette façon a été crée EcologyCare, le nouveau logo qui garantit un lavage et une hygiène professionnels, ainsi qu’un bas impact sur l’environnement et une économie d’eau et d’énergie majeure.*

*Krupps hat einen “nachhaltigen” Charakter.*

*Seit mehr als 45 Jahren plant und herstellt Krupps innovative Produkte im totalen Respekt gegenüber der Umwelt.*

*Auf diese Weise entstand EcologyCare, das neue Logo, das eine professionelle Spülung und Hygiene mit sehr niedrigen Umweltauswirkungen und einer höheren Wasser- und Stromersparung garantiert.*



# CUBE Line

- 07.....C320
- 08.....C320R
- 09.....C327
- 10.....C327R
- 11.....C426
- 12.....C426R
- 13.....C432
- 14.....C432R
- 15.....C453
- 16.....C453T
- 17.....C537
- 18.....C537T
- 19.....C640

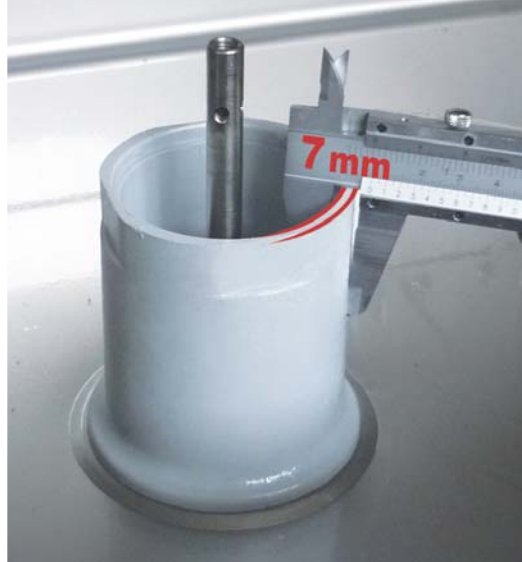



**CUBE, semplice nella forma, robusta nella meccanica, è la linea che introduce la vasta gamma di lavastoviglie Krupps.**

*CUBE, simple dans sa forme, solide dans sa structure, est la ligne qui introduit la large gamme de lave-vaisselle Krupps.*

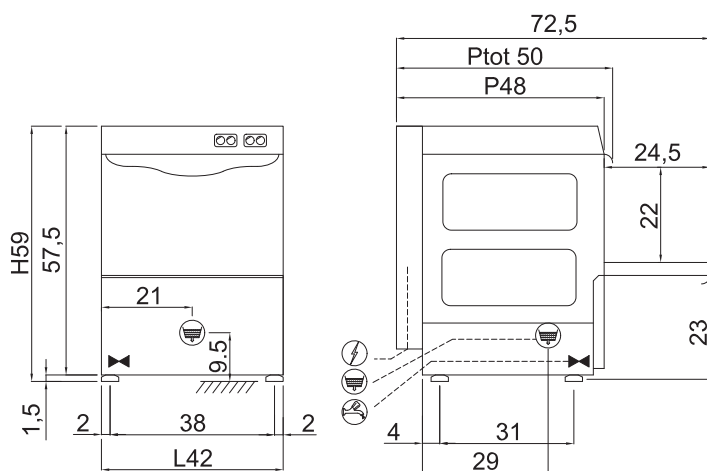
*CUBE, einfache Form, feste Struktur, ist die Linie, die die große Geschirrspüler-Auswahl von Krupps einführt.*



**Dotazione standard | Dotation standard | Standardausstattung**

	207054	Cesto per bicchieri dim. 35x35x10 cm Panier pour verres dim. 35x35x10 cm Gläserkorb Abmess. 35x35x10 cm	2
	1150	Portacucchiaini Porte-petites cuillères Löffelchenhalter	1
	1153	Portapiattini 12 posti Porte-petites assiettes à 12 pièces 12-Stück Untertassenhalter	1

**Imballo | Emballage | Verpackung**

	Dimensioni 66x56,5x80h cm Dimensions Maße
	Volume 0,30 m <sup>3</sup> Volume Volumen
	Peso 35 Kg Poids Gewicht

Technical specifications and features represented by icons:

- 35 cm (Glass rack width)
- 120 sec (Cycle time)
- 30 pz./h (Washing speed)
- 19,5 cm (Glass height)
- 3,0 Kw / 13 lt. (Energy and water consumption)
- 3,3 Kw / 3,2 lt. (Energy and water consumption)
- WASH PUMP 0,35 HP / 0,26 Kw (Washing pump power)
- WASH PUMP 180 lt/min (Washing pump flow rate)
- TOTAL POWER 3,56 Kw (Total power consumption)
- 230V 50/60Hz (Voltage and frequency)
- +55°C (Water temperature)
- 2,0 lt/cycle (Water consumption per cycle)
- 1,5 cm (Base height)
- <70 dB (Noise level)
- ecologycare (Eco-friendly feature)
- CE (CE mark)





# CUBE C320R I

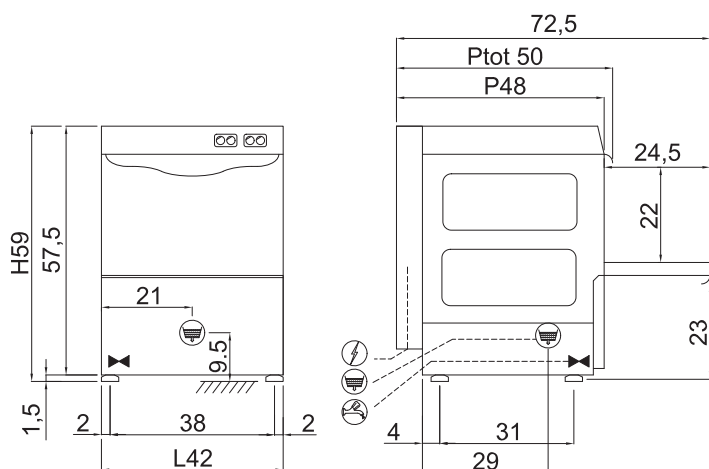

Ø 35 cm



## Dotazione standard | Dotation standard | Standardausstattung

	207035	Cesto per bicchieri ø 35 cm Panier pour verres ø 35 cm Gläserkorb ø 35 cm	2
	1150	Portacucchiaini Porte-petites cuillères Löffelchenhalter	1
	1153	Portapiattini 12 posti Porte-petites assiettes à 12 pièces 12-Stück Untertassenhalter	1

## Imballo | Emballage | Verpackung

	Dimensioni 66x56,5x80h cm Dimensions Maße
	Volume 0,30 m <sup>3</sup> Volume Volumen
	Peso 35 Kg Poids Gewicht

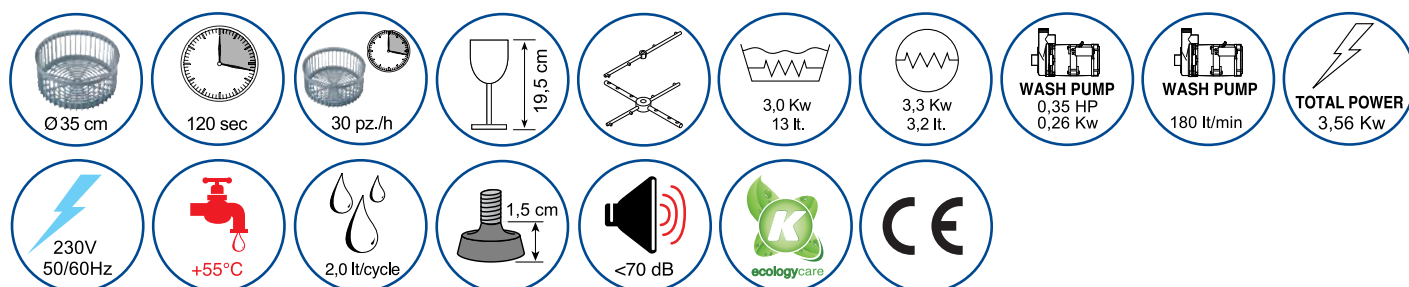



# CUBE C327 I

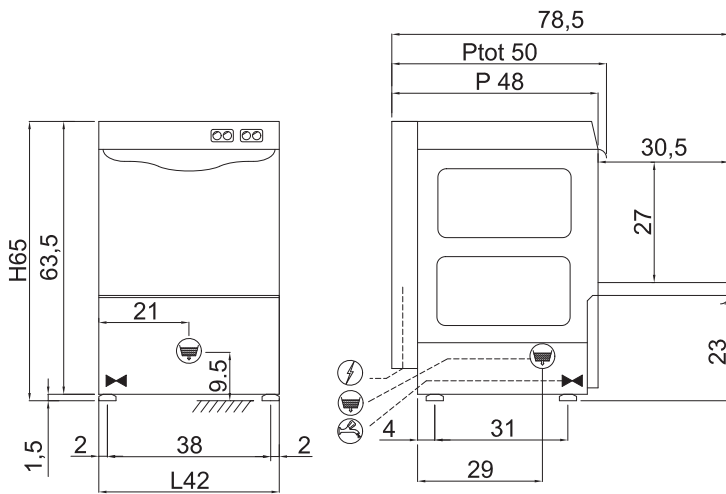

## Dotazione standard | Dotation standard | Standardausstattung

	207054	Cesto per bicchieri dim. 35x35x10 cm Panier pour verres dim. 35x35x10 cm Gläserkorb Abmess. 35x35x10 cm	2
	1150	Portacucchiaini Porte-petites cuillères Löffelchenhalter	1
	1153	Portapiattini 12 posti Porte-petites assiettes à 12 pièces 12-Stück Untertassenhalter	1

## Imballo | Emballage | Verpackung

	Dimensioni 66x56,5x80h cm Dimensions Maße
	Volume 0,30 m <sup>3</sup> Volume Volumen
	Peso 36 Kg Poids Gewicht

- 35 cm (Glass rack width)
- 120 sec (Cycle time)
- 30 pz./h (Wash speed)
- 24 cm (Glass height)
- 3,0 Kw / 13 lt. (Energy and water consumption)
- 3,3 Kw / 3,2 lt. (Energy and water consumption)
- WASH PUMP 0,35 HP / 0,26 Kw (Wash pump power)
- WASH PUMP 180 lt/min (Wash pump flow)
- TOTAL POWER 3,56 Kw (Total power)
- 230V 50/60Hz (Voltage and frequency)
- +55°C (Water temperature)
- 2,0 lt/cycle (Water consumption)
- 1,5 cm (Base height)
- <70 dB (Noise level)
- ecologycare (Eco-friendly feature)
- CE (CE mark)





# CUBE C327R I

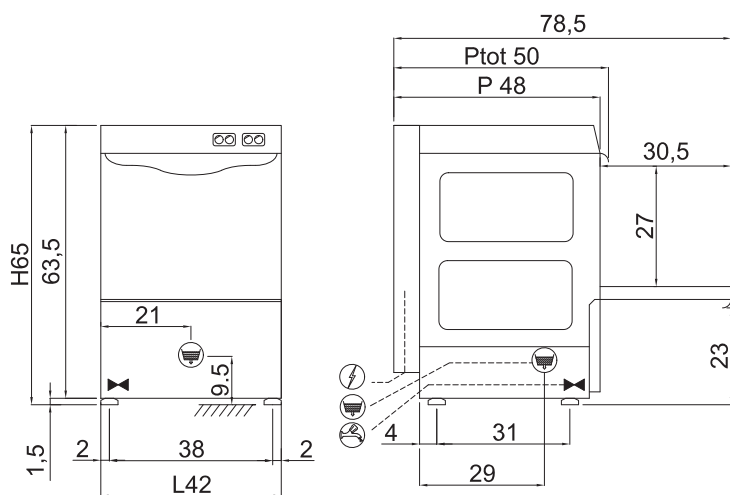

Ø 35 cm



## Dotazione standard | Dotation standard | Standardausstattung

	207035	Cesto per bicchieri ø 35 cm Panier pour verres ø 35 cm Gläserkorb ø 35 cm	2
	1150	Portacucchiaini Porte-petites cuillères Löffelchenhalter	1
	1153	Portapiattini 12 posti Porte-petites assiettes à 12 pièces 12-Stück Untertassenhalter	1

## Imballo | Emballage | Verpackung

	Dimensioni 66x56,5x80h cm Dimensions Maße
	Volume 0,30 m <sup>3</sup> Volume Volumen
	Peso 36 Kg Poids Gewicht

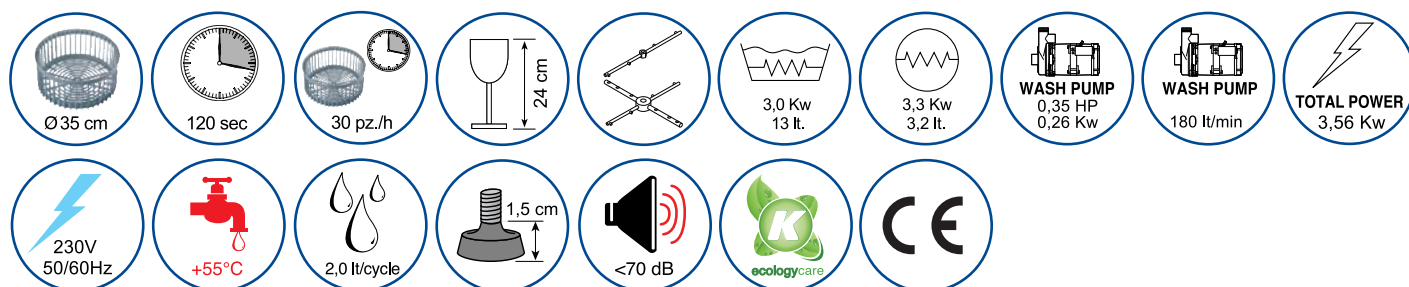



# CUBE C426 I

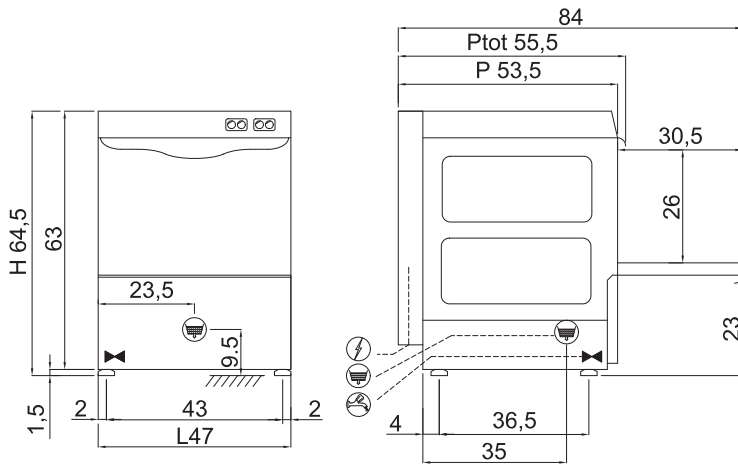

### Dotazione standard | Dotation standard | Standardausstattung

	208054	Cesto per bicchieri dim.40x40x10 cm Panier pour verres dim. 40x40x10 cm Gläserkorb Abmess. 40x40x10 cm	2
	1150	Portacucchiaini Porte-petites cuillères Löffelchenhalter	1
	1153	Portapiattini 12 posti Porte-petites assiettes à 12 pièces 12-Stück Untertassenhalter	1

### Imballo | Emballage | Verpackung

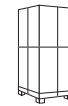

Dimensioni 66x56,5x85h cm  
Dimensions  
Maße

Volume 0,32 m<sup>3</sup>  
Volume  
Volumen

Peso 38 Kg  
Poids  
Gewicht

40 cm	120 sec	30 pz./h	23,5 cm	25,5 cm		3,0 Kw 17 lt.	3,3 Kw 3,2 lt.	WASH PUMP 0,35 HP 0,26 Kw	WASH PUMP 180 lt/min
TOTAL POWER 3,56 Kw	230V 50/60Hz	+55°C	2,0 lt/cycle	1,5 cm	<70 dB				





# CUBE C426R I

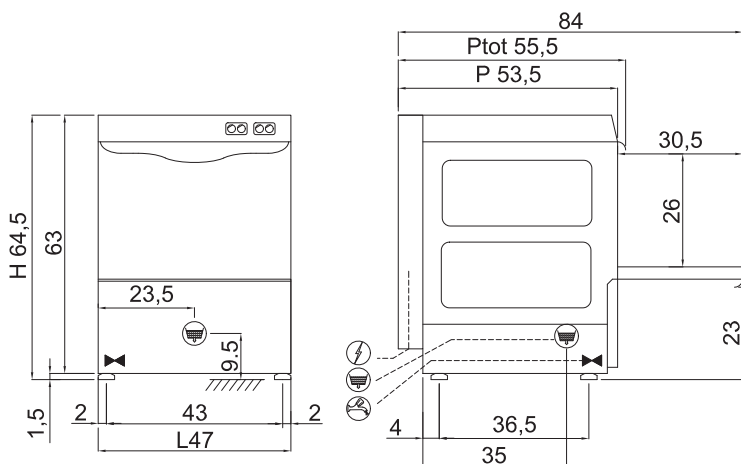

Ø40 cm















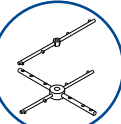
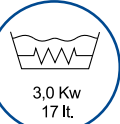
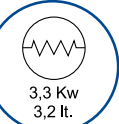

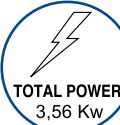
## Dotazione standard | Dotation standard | Standardausstattung

	208035	Cesto tondo in plastica ø 40 cm Panier rond en plastique ø 40 cm Runder Korb aus Plastik ø 40 cm	2
	1150	Portacucchiaini Porte-petites cuillères Löffelchenhalter	1
	1153	Portapiattini 12 posti Porte-petites assiettes à 12 pièces 12-Stück Untertassenhalter	1

## Imballo | Emballage | Verpackung

	Dimensioni 66x56,5x85h cm Dimensions Maße
	Volume 0,32 m <sup>3</sup> Volume Volumen
	Peso 38 Kg Poids Gewicht



 Ø40 cm	 120 sec	 30 pz./h	 23,5 cm	 25,5 cm		 3,0 Kw 17 lt.	 3,3 Kw 3,2 lt.	 WASH PUMP 0,35 HP 0,26 Kw	 WASH PUMP 180 lt/min
 TOTAL POWER 3,56 Kw	 230V 50/60Hz	 +55°C	 2,0 lt/cycle	 1,5 cm	 <70 dB	 ecologycare	 CE		

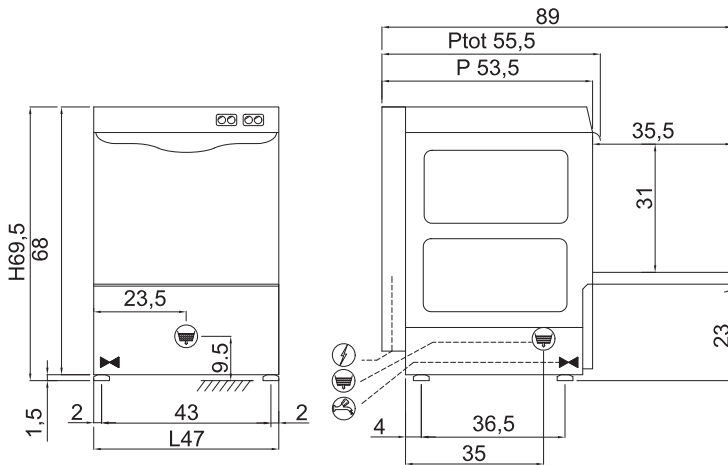

# CUBE C432 I



## Dotazione standard | Dotation standard | Standardausstattung

	208054	Cesto per bicchieri dim.40x40x10 cm Panier pour verres dim. 40x40x10 cm Gläserkorb Abmess. 40x40x10 cm	2
	1150	Portacucchiaini Porte-petites cuillères Löffelchenhalter	1
	1153	Portapiattini 12 posti Porte-petites assiettes à 12 pièces 12-Stück Untertassenhalter	1









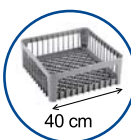

## Imballo | Emballage | Verpackung

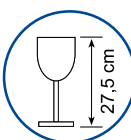
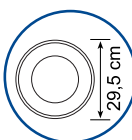
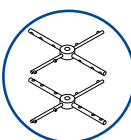
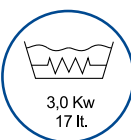
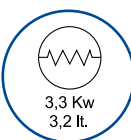
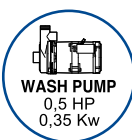

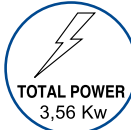
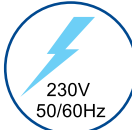
Dimensioni 66x56,5x85h cm  
Dimensions  
Maße

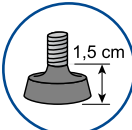
Volume 0,32 m<sup>3</sup>  
Volume  
Volumen

Peso 40 Kg  
Poids  
Gewicht

 40 cm	 120 sec	 30 pz./h	 27,5 cm	 29,5 cm		 3,0 Kw 17 lt.	 3,3 Kw 3,2 lt.	 WASH PUMP 0,5 HP 0,35 Kw	 WASH PUMP 220 lt/min
 TOTAL POWER 3,56 Kw	 230V 50/60Hz	 +55°C	 2,0 lt/cycle	 1,5 cm	 <70 dB	 ecologycare	 CE		





# CUBE C432R I

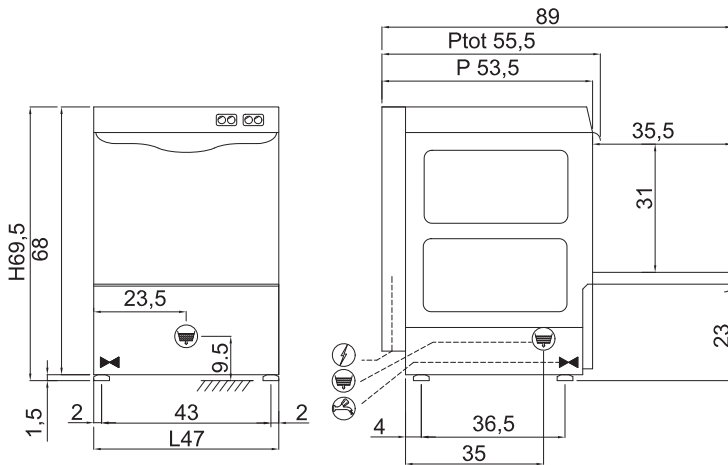

Ø40 cm



## Dotazione standard | Dotation standard | Standardausstattung

	208035	Cesto tondo in plastica ø 40 cm Panier rond en plastique ø 40 cm Runder Korb aus Plastik ø 40 cm	2
	1150	Portacucchiaini Porte-petites cuillères Löffelchenhalter	1
	1153	Portapiattini 12 posti Porte-petites assiettes à 12 pièces 12-Stück Untertassenhalter	1

## Imballo | Emballage | Verpackung

	Dimensioni 66x56,5x85h cm Dimensions Maße
	Volume 0,32 m <sup>3</sup> Volume Volumen
	Peso 40 Kg Poids Gewicht

Technical specifications and features represented by icons:





- Ø40 cm (Basket diameter)
- 120 sec (Cycle time)
- 30 pz./h (Washing speed)
- 27,5 cm (Glass height)
- 29,5 cm (Plate height)
- 3,0 Kw 17 lt. (Water consumption)
- 3,3 Kw 3,2 lt. (Energy consumption)
- WASH PUMP 0,5 HP 0,35 Kw 220 lt/min (Pump specifications)
- TOTAL POWER 3,56 Kw (Total power)
- 230V 50/60Hz (Voltage and frequency)
- +55°C (Water temperature)
- 2,0 lt/cycle (Water consumption per cycle)
- 1,5 cm (Door thickness)
- <70 dB (Noise level)
- ecologycare (Eco-friendly feature)
- CE (CE mark)

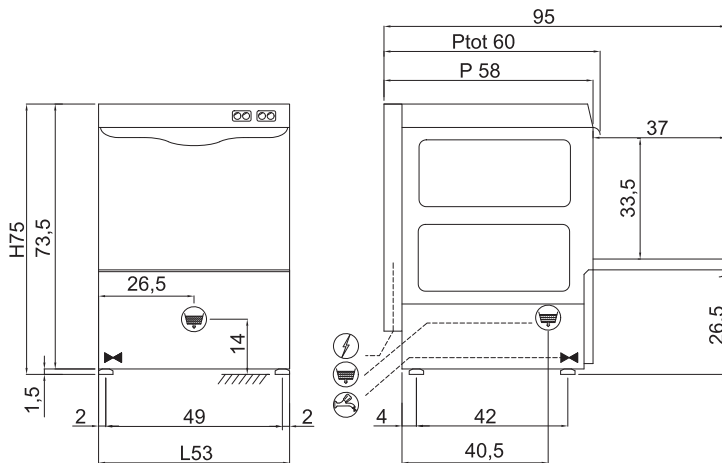

# CUBE C453 I



## Dotazione standard | Dotation standard | Standardausstattung

	210054	Cesto per bicchieri dim.45x45x10 cm Panier pour verres dim. 45x45x10 cm Gläserkorb Abmess.45x45x10 cm	1
	210055	Cestello in plastica 14 piatti Panier en plastique 14 assiettes Korb aus Plastik für 14 Teller	1
	1151	Portaposate Porte-couverts Besteckhalter	1
	1153	Portapiattini 12 posti Porte-petites assiettes à 12 pièces 12-Stück Untertassenhalter	1









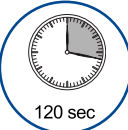

## Imballo | Emballage | Verpackung

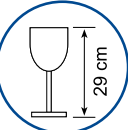
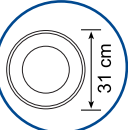
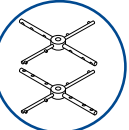
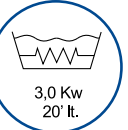
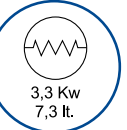
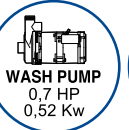

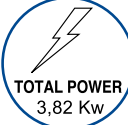
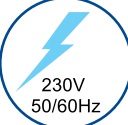
Dimensioni 67x80x90h cm  
Dimensions  
Maße

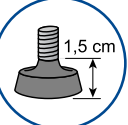
Volume 0,48 m<sup>3</sup>  
Volume  
Volumen

Peso 44 Kg  
Poids  
Gewicht





 45 cm	 120 sec	 30 pz./h	 29 cm	 31 cm		 3,0 Kw 20' lt.	 3,3 Kw 7,3 lt.	 WASH PUMP 0,7 HP 0,52 Kw	 WASH PUMP 300 lt/min
 TOTAL POWER 3,82 Kw	 230V 50/60Hz	 +55°C	 2,0 lt/cycle	 1,5 cm	 <70 dB	 ecologycare	 CE		

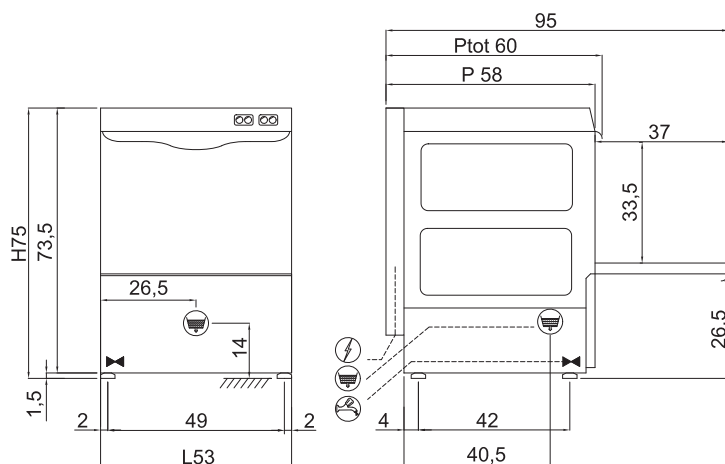

# CUBE C453T I



## Dotazione standard | Dotation standard | Standardausstattung

	210054	Cesto per bicchieri dim.45x45x10 cm Panier pour verres dim. 45x45x10 cm Gläserkorb Abmess.45x45x10 cm	1
	210055	Cestello in plastica 14 piatti Panier en plastique 14 assiettes Korb aus Plastik für 14 Teller	1
	1151	Portaposate Porte-couverts Besteckhalter	1
	1153	Portapiattini 12 posti Porte-petites assiettes à 12 pièces 12-Stück Untertassenhalter	1



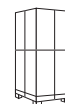







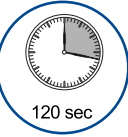

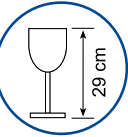
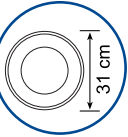
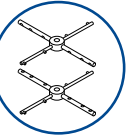
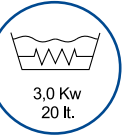
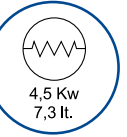
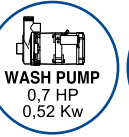
## Imballo | Emballage | Verpackung

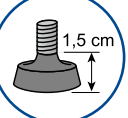

Dimensioni 67x80x90h cm  
Dimensions  
Maße

Volume 0,48 m<sup>3</sup>  
Volume  
Volumen

Peso 44 Kg  
Poids  
Gewicht

 45 cm	 120 sec	 30 pz./h	 29 cm	 31 cm		 3,0 Kw 20 lt.	 4,5 Kw 7,3 lt.	 WASH PUMP 0,7 HP 0,52 Kw	 WASH PUMP 300 lt/min
 TOTAL POWER 5,02 Kw	 400V3N+T 50/60Hz	 +55°C	 2,0 lt/cycle	 1,5 cm	 <70 dB	 ecologycare	 CE		



# CUBE C537 I

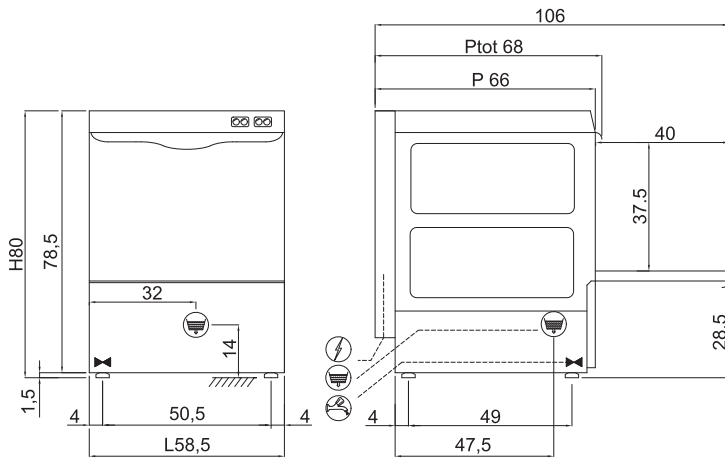

## Dotazione standard | Dotation standard | Standardausstattung

	800201	Cesto quadrato in plastica maglia stretta Panier carré en plastique avec maille étroite Quadratischer Korb aus Plastik mit enger Struktur	1
	800211	Cestello in plastica 18 piatti Panier en plastique 18 assiettes Plastik Korb für 18 Teller	1
	1151	Portaposate Porte-couverts Besteckhalter	2

## Imballo | Emballage | Verpackung



Dimensioni 67x80x90h cm  
Dimensions  
Maße

Volume 0,51 m<sup>3</sup>  
Volume  
Volumen

Peso 62 Kg  
Poids  
Gewicht



- 50 cm (basket width)
- 120 sec (cycle time)
- 30 pz./h (cycles per hour)
- 31 cm (cup height)
- 33 cm (plate height)
- GN 1/1 MAX 53x32,5 (tray size)
- 3,0 Kw 26 lt. (water consumption)
- 3,3 Kw 7,3 lt. (energy consumption)
- WASH PUMP 0,7 HP 0,52 Kw (pump power)
- WASH PUMP 300 lt/min (pump flow)
- TOTAL POWER 3,82 Kw (total power)
- 230V 50/60Hz (voltage/frequency)
- +55°C (max temperature)
- 2,0 lt/cycle (water per cycle)
- 1,5 cm (height)
- <70 dB (noise level)
- ecologycare (eco-label)
- CE (CE mark)

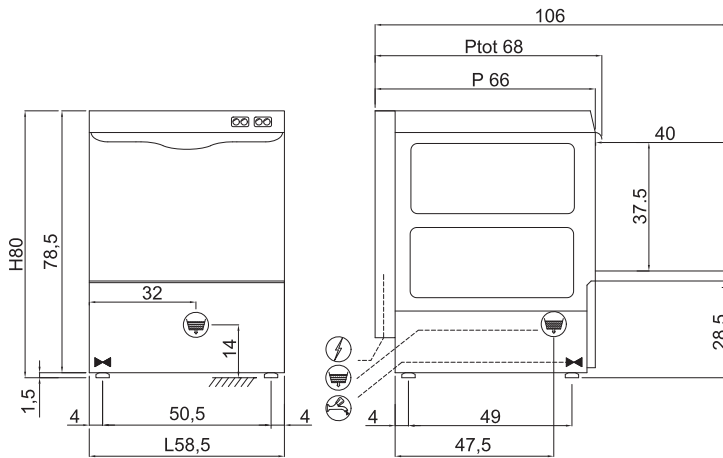

# CUBE C537T I



## Dotazione standard | Dotation standard | Standardausstattung

	800201	Cesto quadrato in plastica maglia stretta Panier carré en plastique avec maille étroite Quadratischer Korb aus Plastik mit enger Struktur	1
	800211	Cestello in plastica 18 piatti Panier en plastique 18 assiettes Plastik Korb für 18 Teller	1
	1151	Portaposate Porte-couverts Besteckhalter	2

## Imballo | Emballage | Verpackung

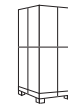

Dimensioni 67x80x90h cm  
Dimensions  
Maße

Volume 0,51 m<sup>3</sup>  
Volume  
Volumen

Peso 62 Kg  
Poids  
Gewicht





- 50 cm
- 120 sec
- 30 pz./h
- 31 cm
- 33 cm
- GN 1/1 MAX 53x32,5
- 3,0 Kw 26 lt.
- 4,5 Kw 7,3 lt.
- WASH PUMP 0,7 HP 0,52 Kw
- WASH PUMP 300 lt/min
- TOTAL POWER 5,02 Kw
- 400V3N+T 50/60Hz
- +55°C
- 2,0 lt/cycle
- 1,5 cm
- <70 dB
- ecologycare
- CE

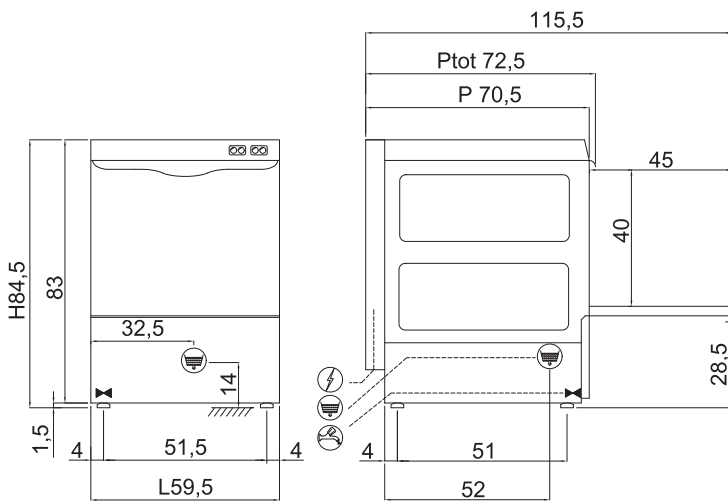
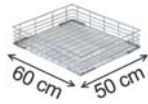

# CUBE C640 I



## Dotazione standard | Dotation standard | Standardausstattung

	640201	Cesto in rete per bicchieri Panier en fil pour verres Drahtkorb für Gläser	1
	640216	Cesto in rete 16 piatti Panier en fil 16 assiettes Drahtkorb für 16 Teller	1
	640200	Cesto porta teglie 4 posti Panier pour plaques 4 compartiments Korb für Backbleche mit 4 Fächern	1
	1154	Portaposate 8 posti Panier à couverts 8 compartiments Besteckhalter mit 8 Fächern	1











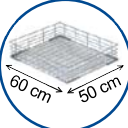

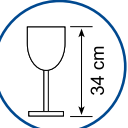
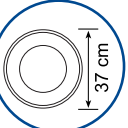

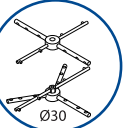
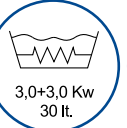
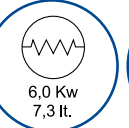
## Imballo | Emballage | Verpackung

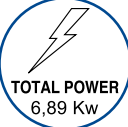

Dimensioni 67x80x90h cm  
Dimensions  
Maße

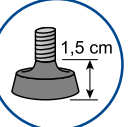
Volume 0,51 m<sup>3</sup>  
Volume  
Volumen

Peso 80 Kg  
Poids  
Gewicht

 60 cm x 50 cm	 120/240/360 sec.	 35/15/10 pz./h	 34 cm	 37 cm	 GN 1/1 MAX 60x40	 Ø30	 3,0+3,0 Kw 30 lt.	 6,0 Kw 7,3 lt.	 WASH PUMP 1,2 HP 0,89 Kw
 WASH PUMP 300 lt/min	 TOTAL POWER 6,89 Kw	 400V3N+T 50/60Hz	 +55°C	 2,0 lt/cycle	 1,5 cm	 <70 dB	 ecologycare		







**KRUPPS Srl** via Austria 19 35127 Padova ITALY  
T. +39 049 7625156 F. +39 049 8704701  
[krupps@krupps.it](mailto:krupps@krupps.it) [krupps.it](http://krupps.it)

